

ORIENTAL 4 40

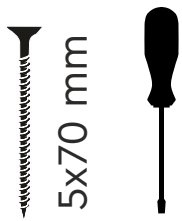

ORIENTAL 4 40

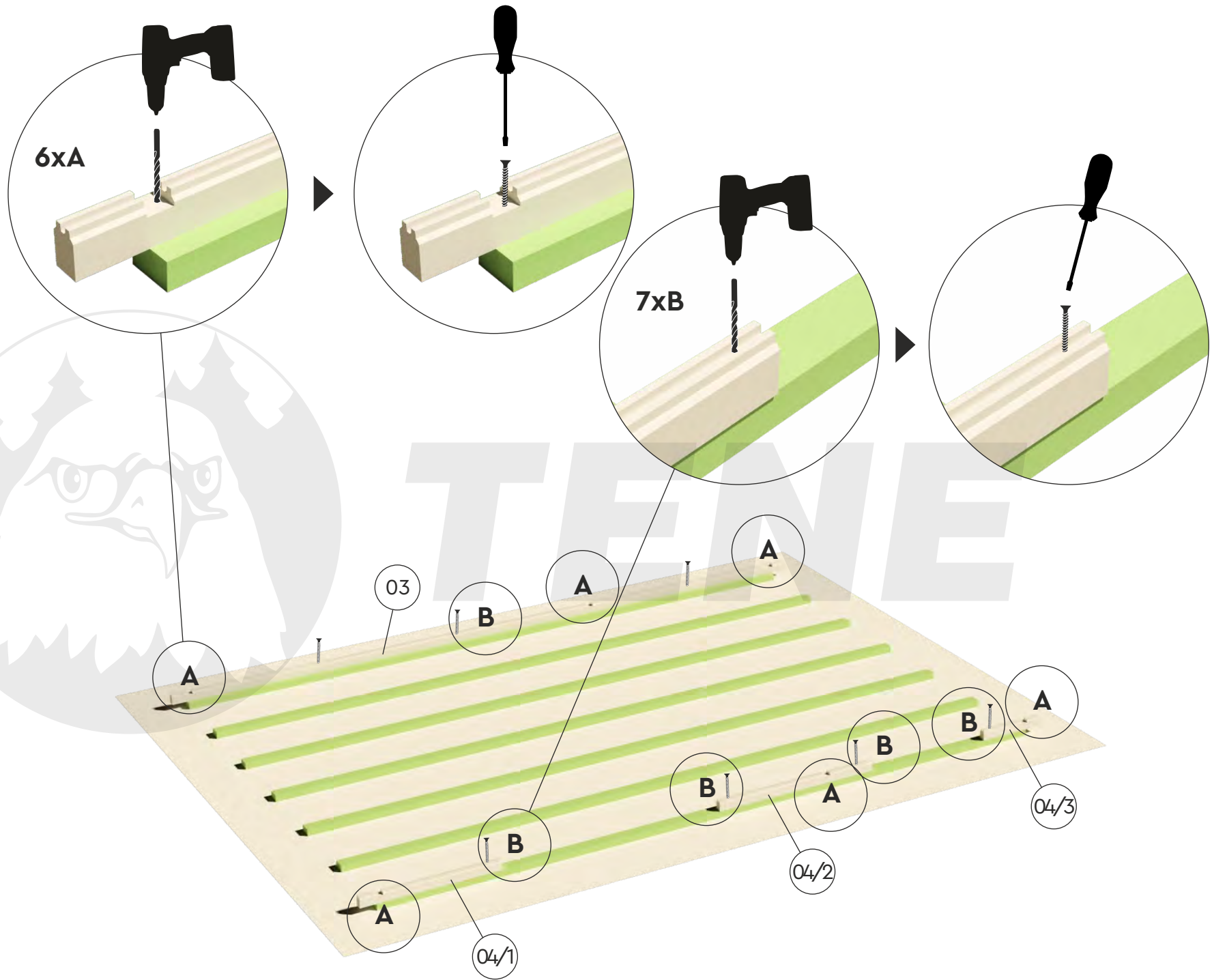
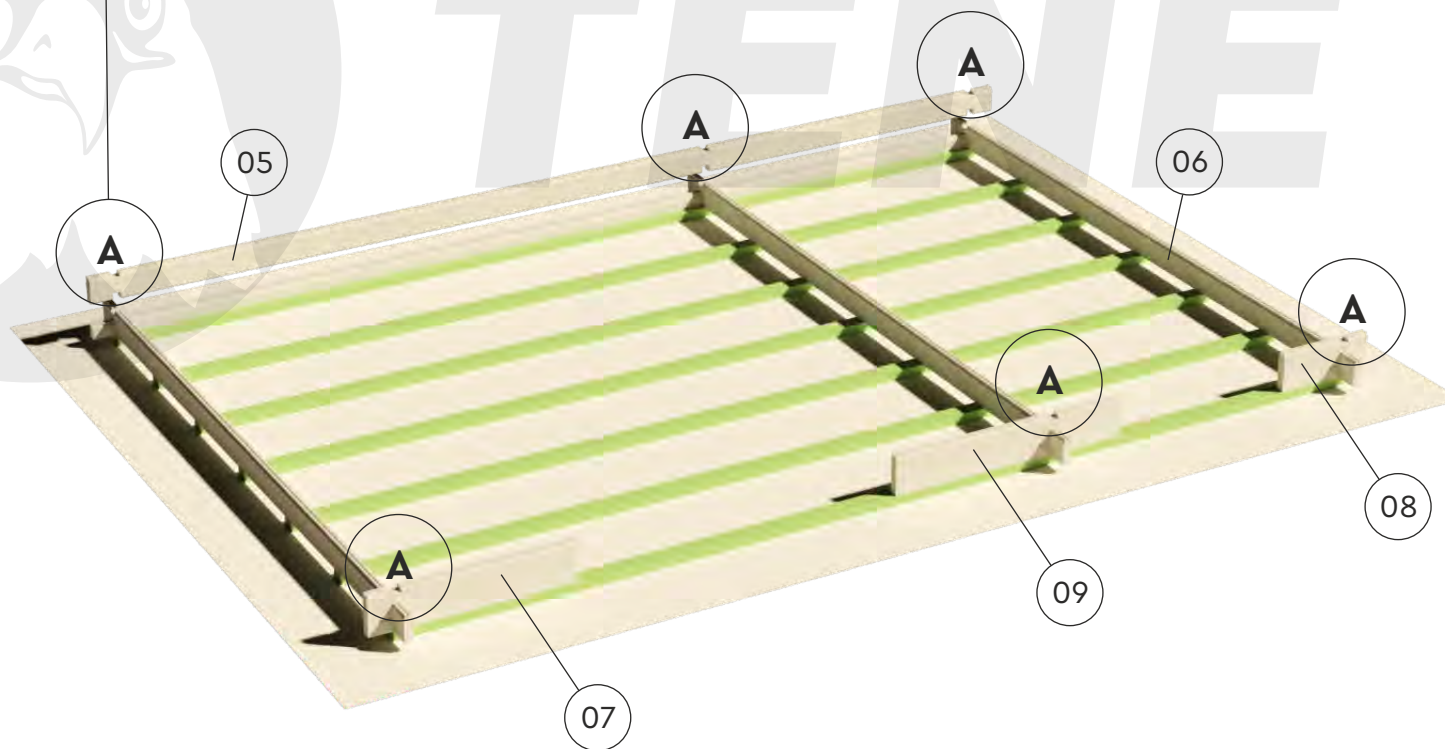
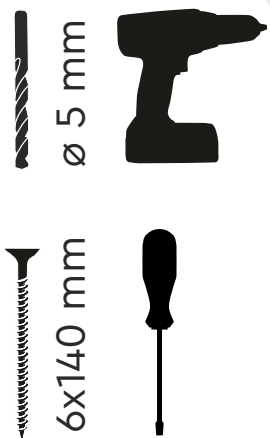
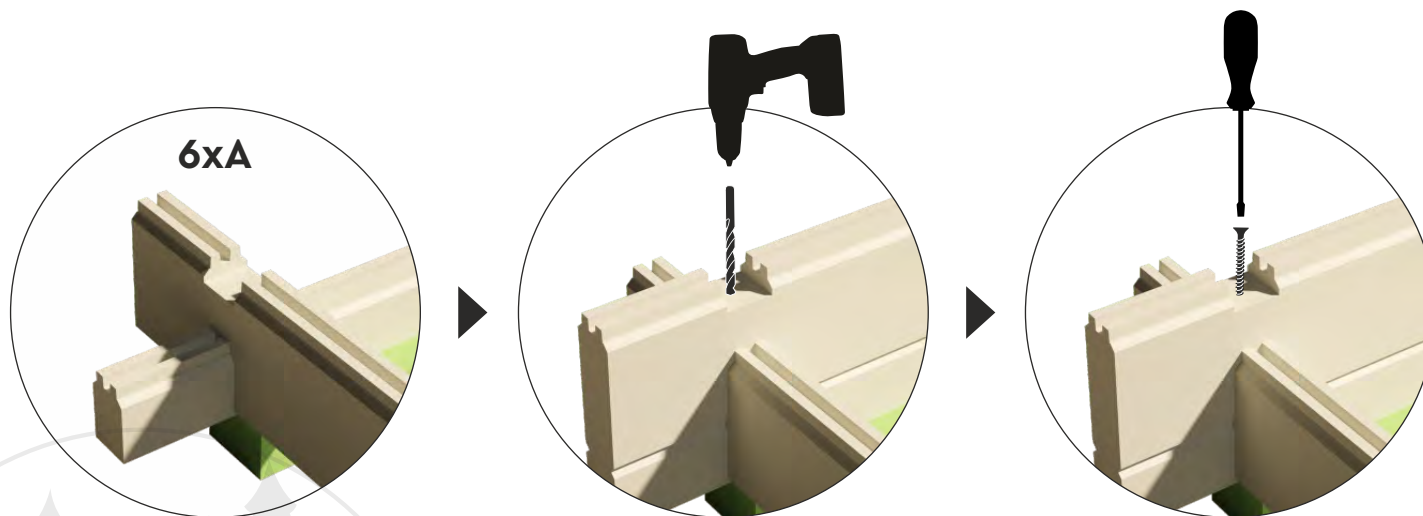

ORIENTAL 4 40

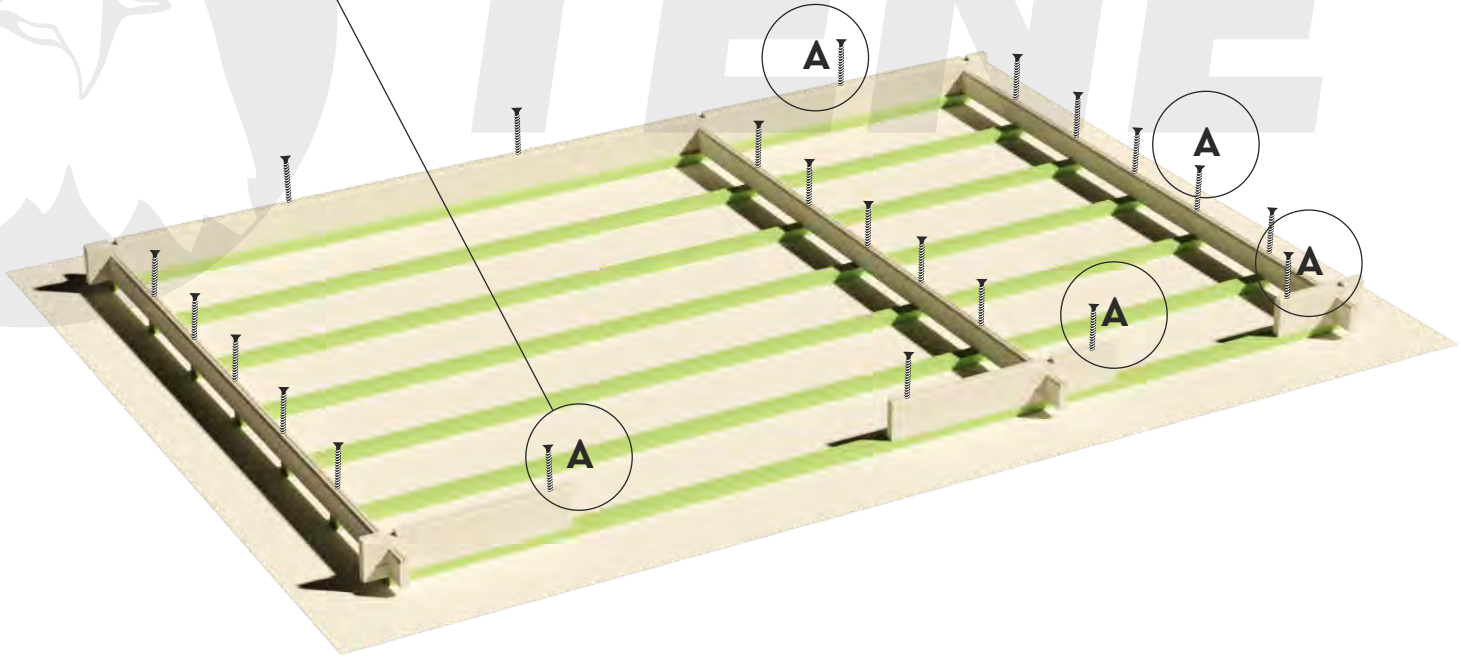
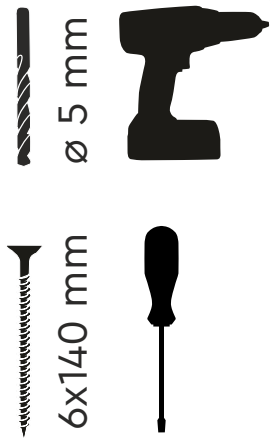
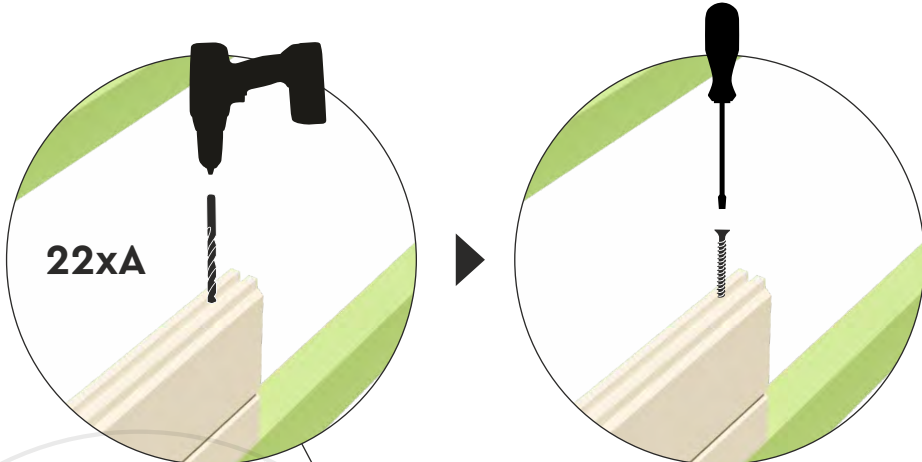

ORIENTAL 4 40

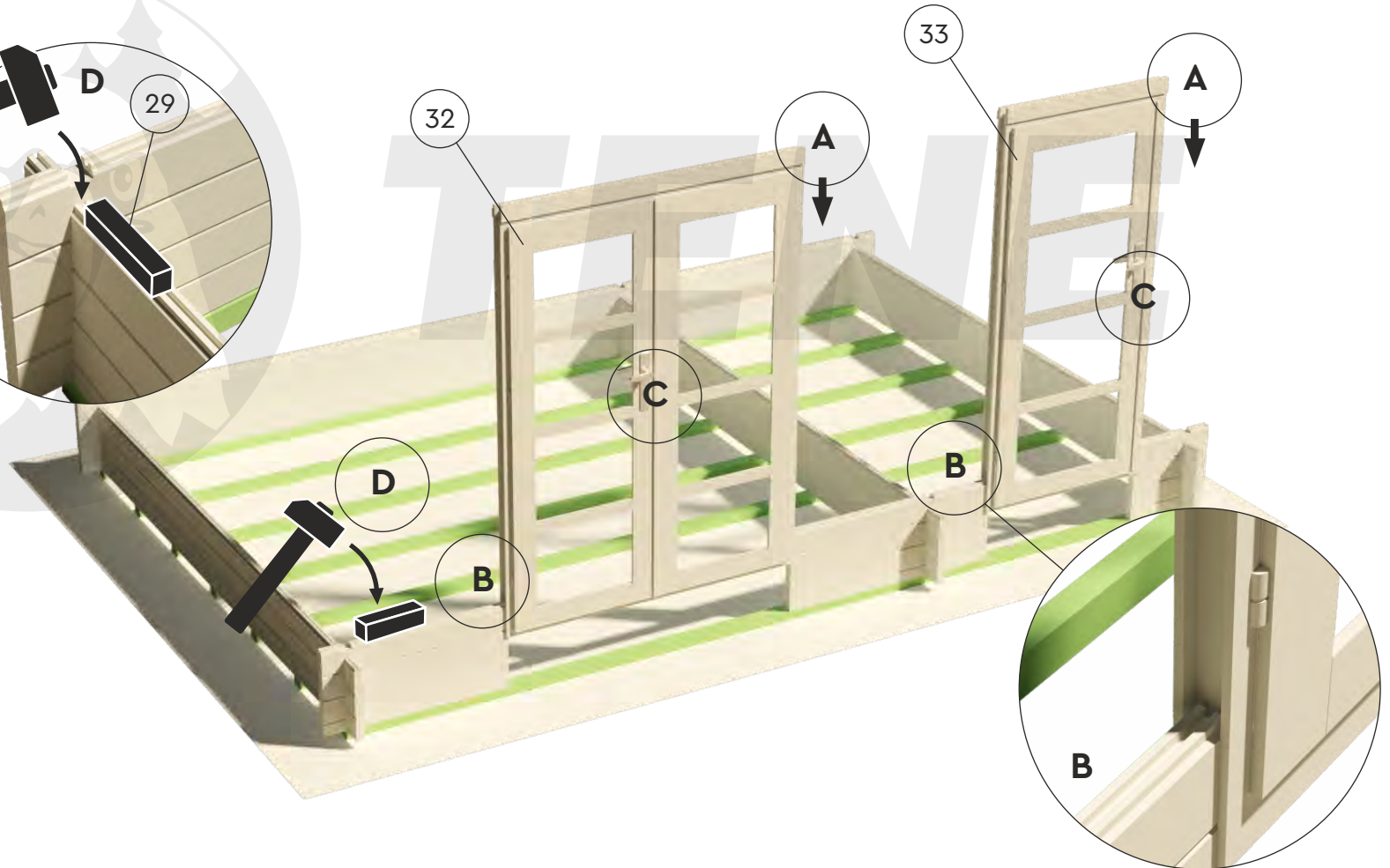
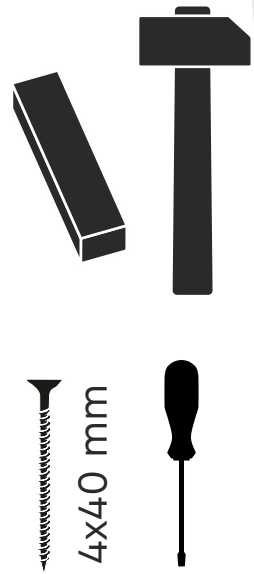
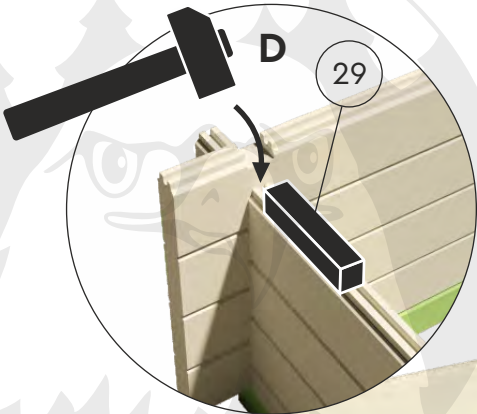
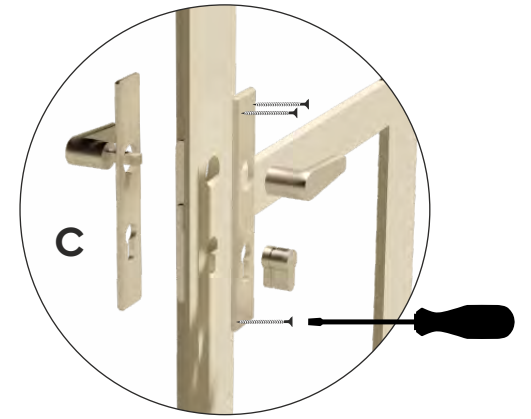
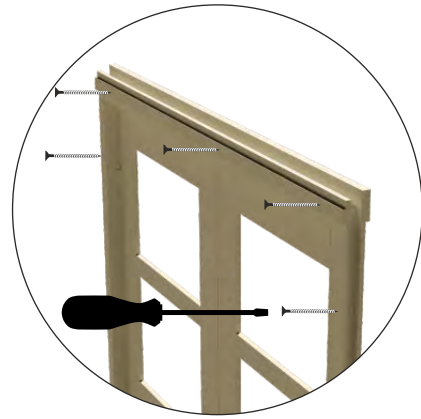
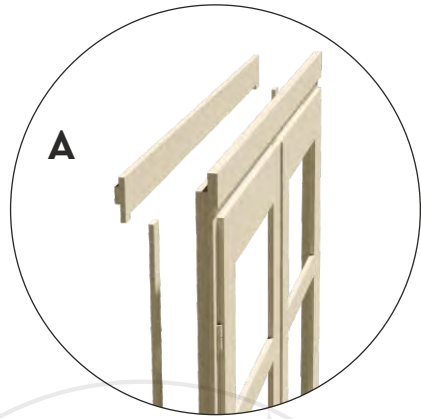

ORIENTAL 4 40

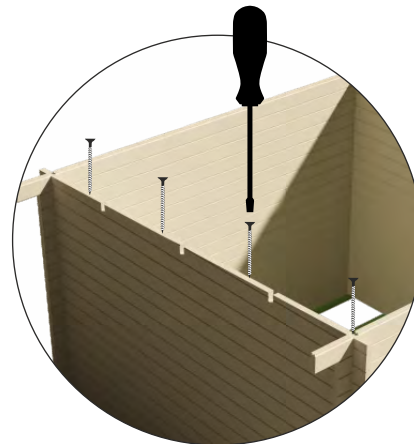
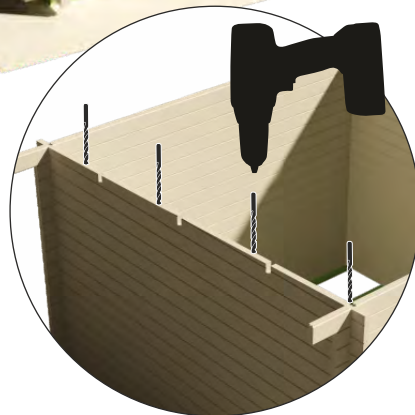
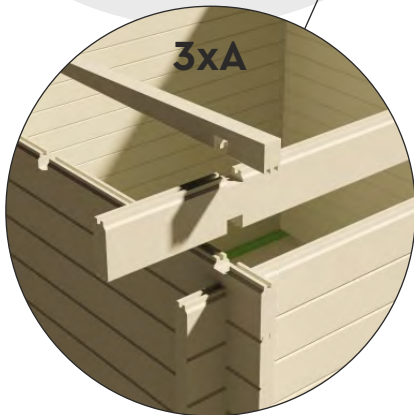
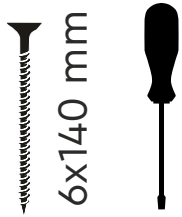
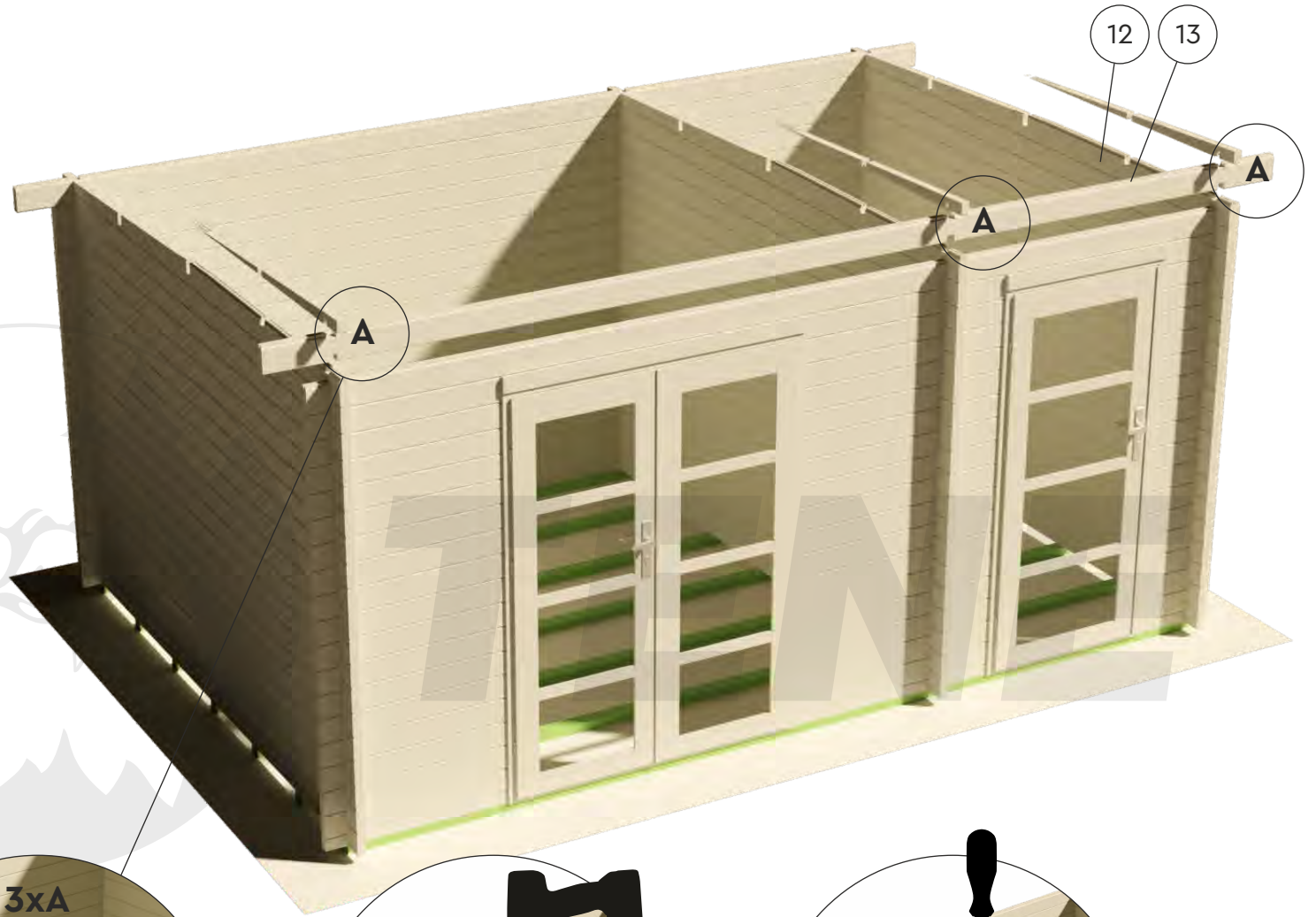

ORIENTAL 4 40

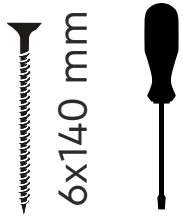
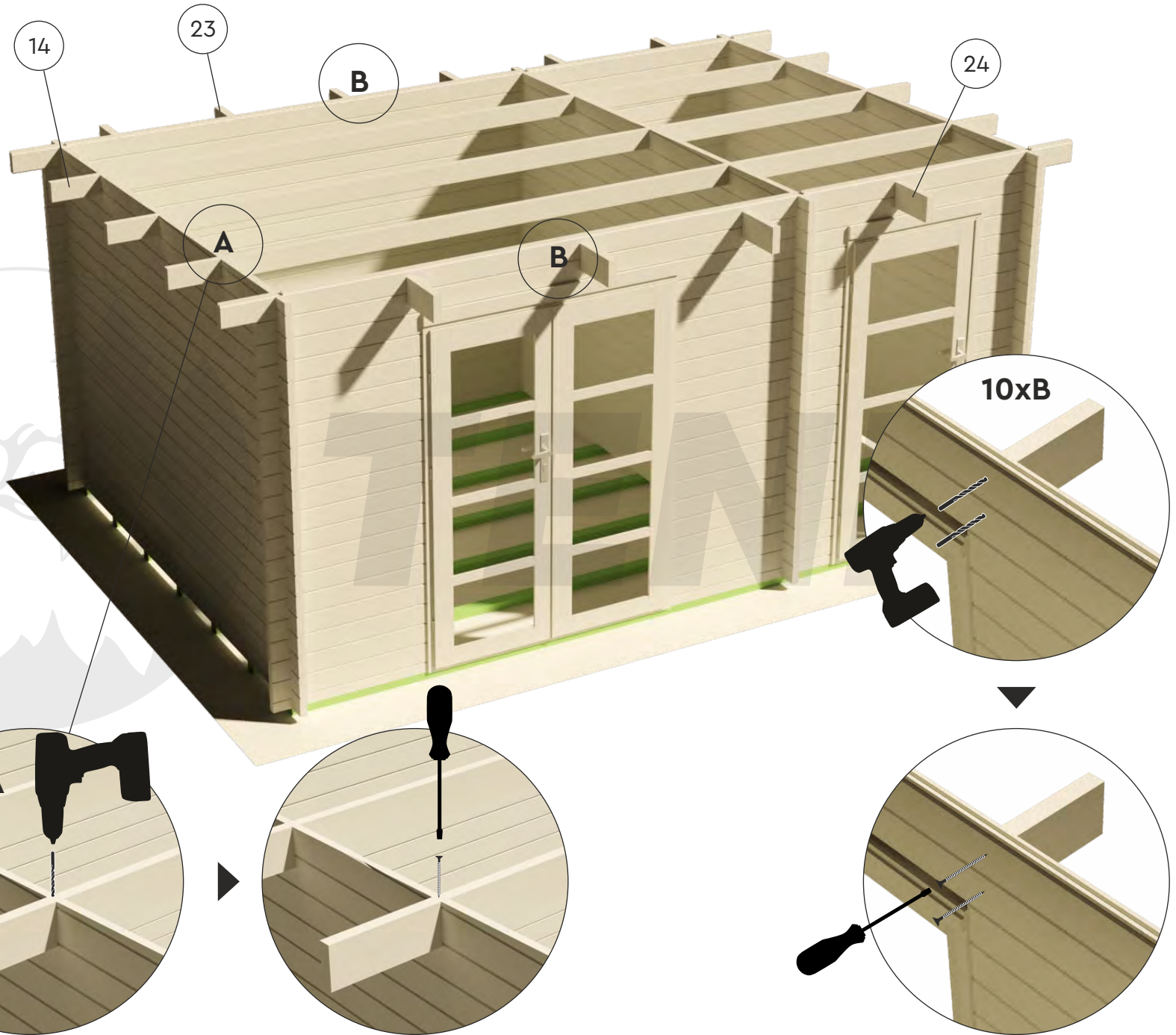

ORIENTAL 4 40



Ø 4 mm



Ø 3 mm



4x70 mm



4x50 mm

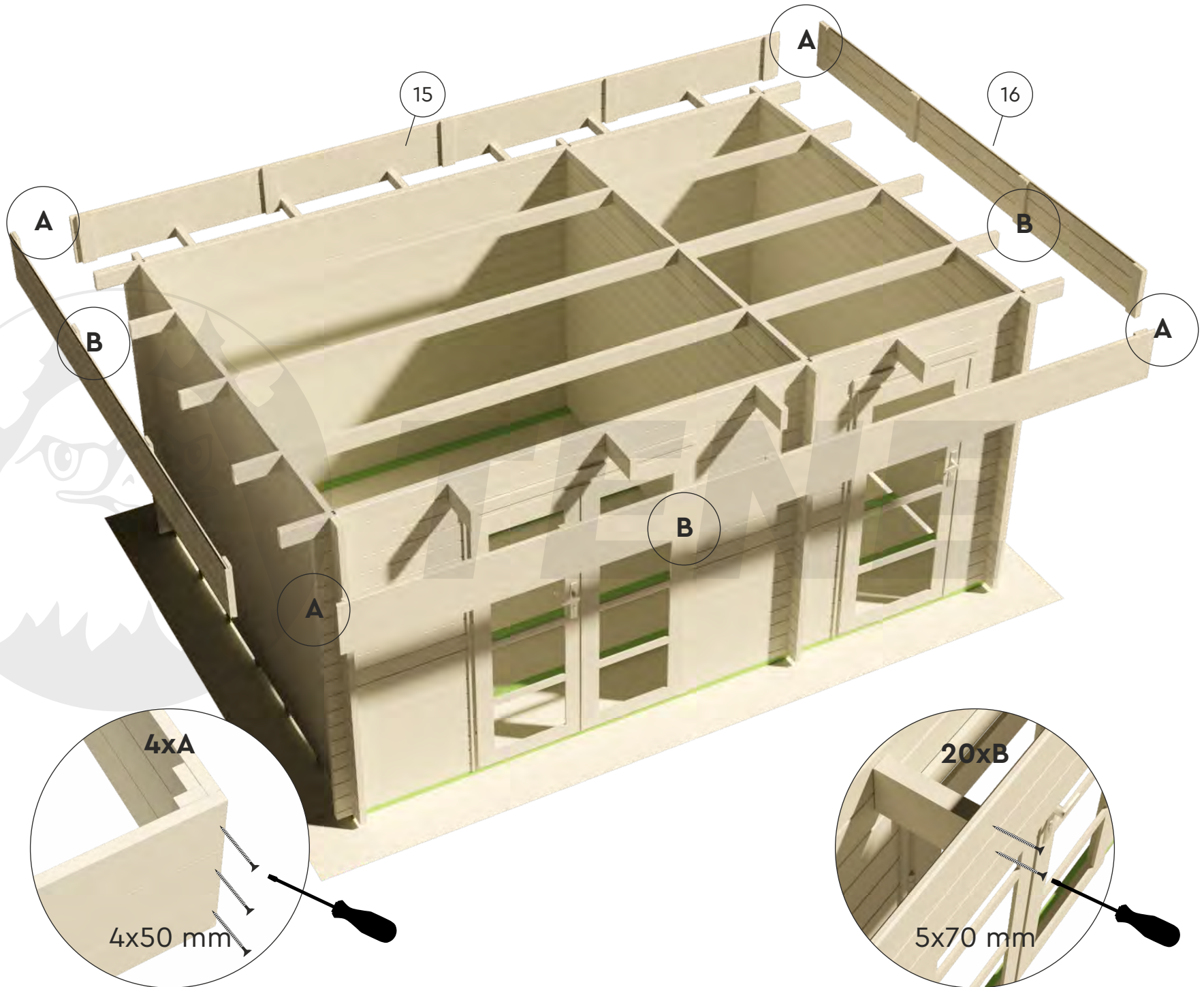

ORIENTAL 4 40

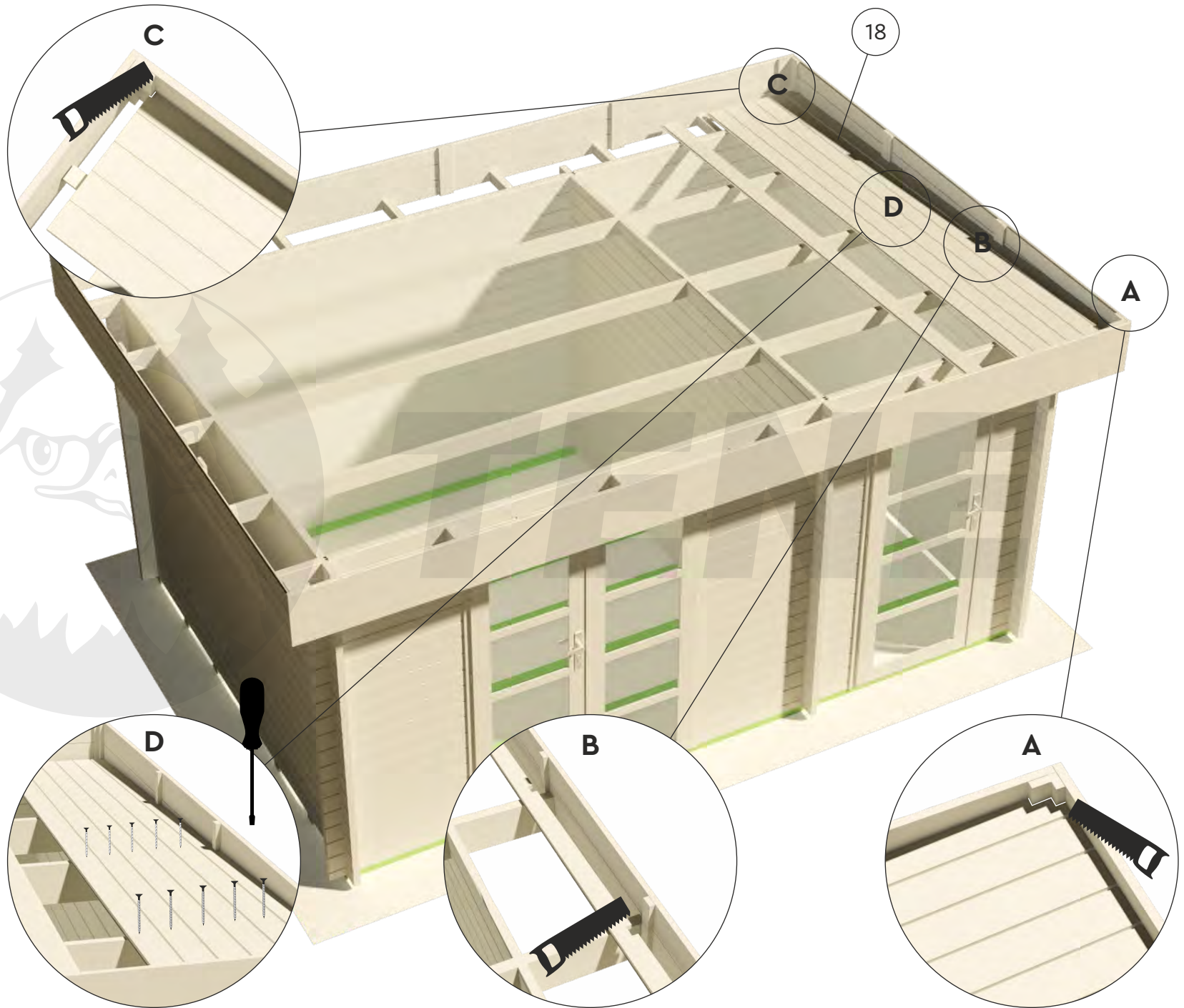

ORIENTAL 4 40

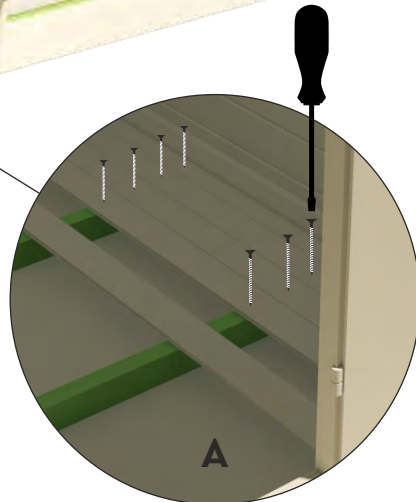
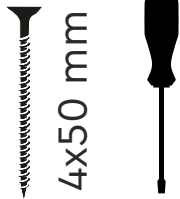
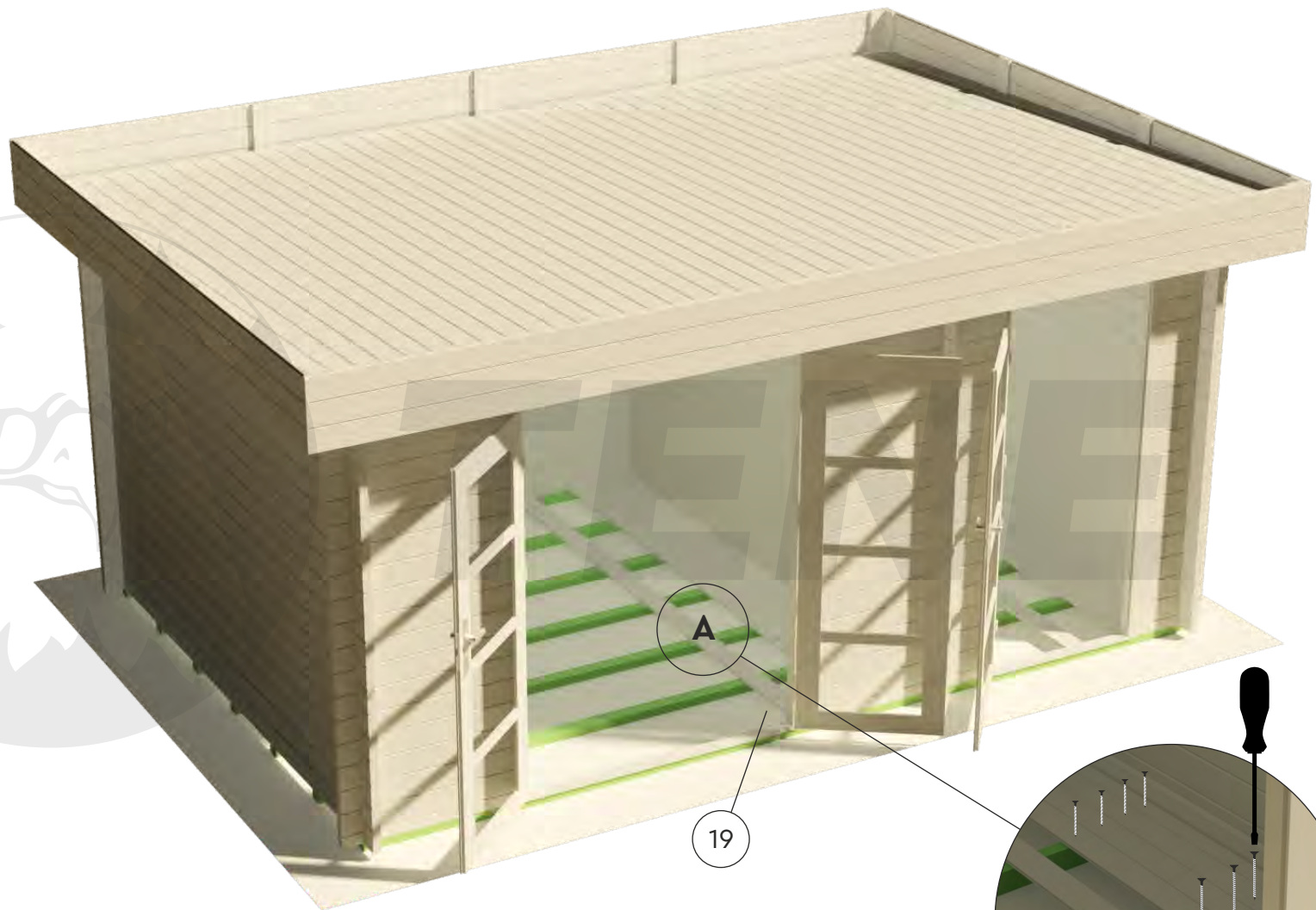

ORIENTAL 4 40

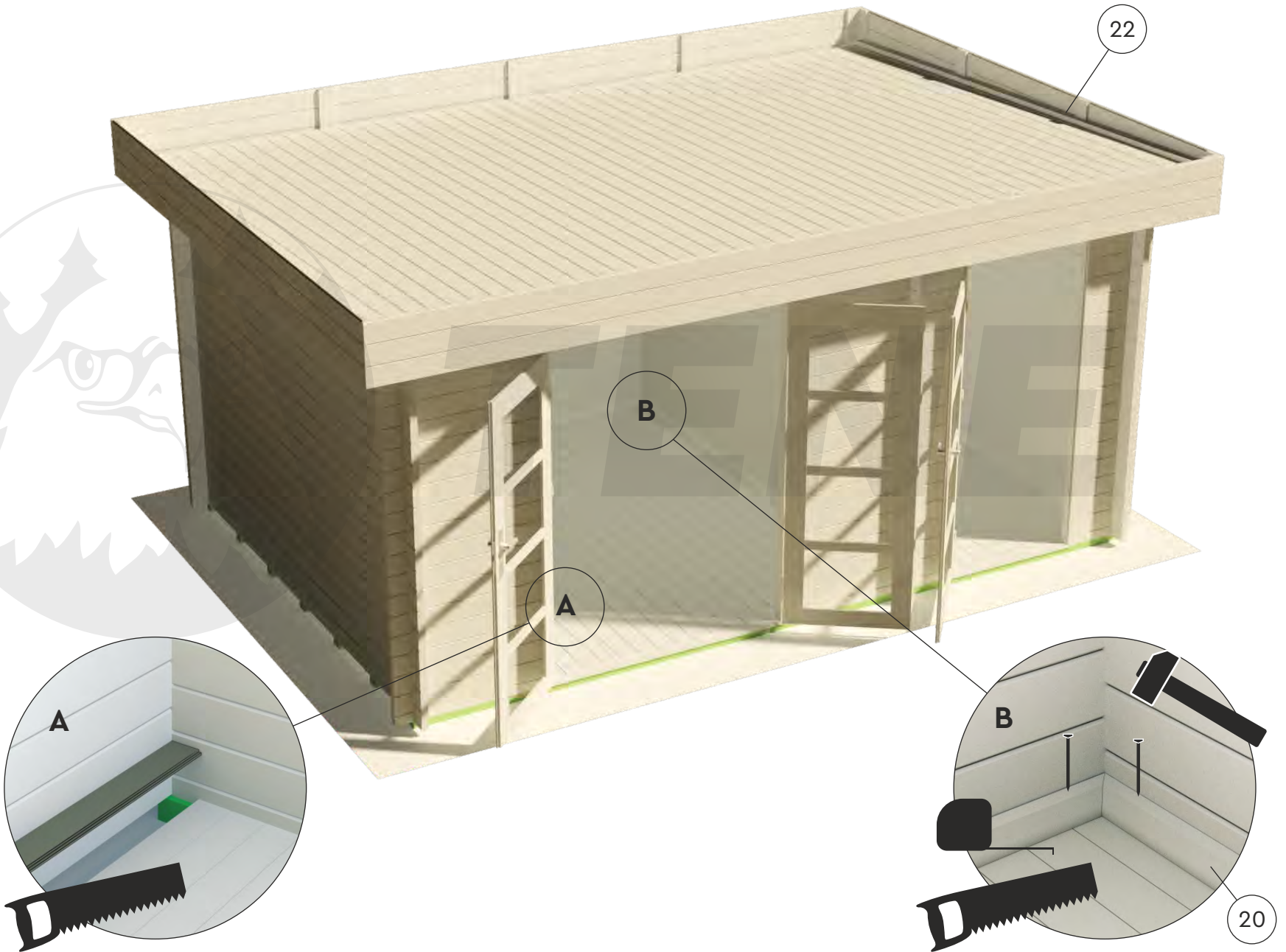
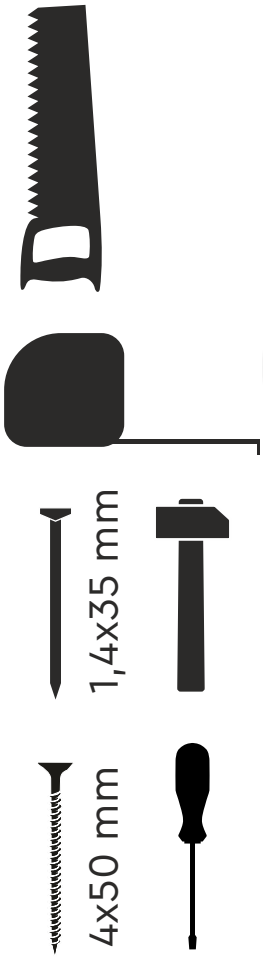

ORIENTAL 4 40

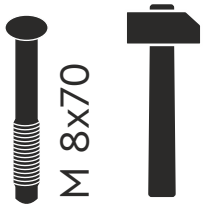
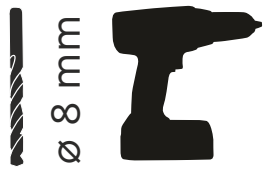
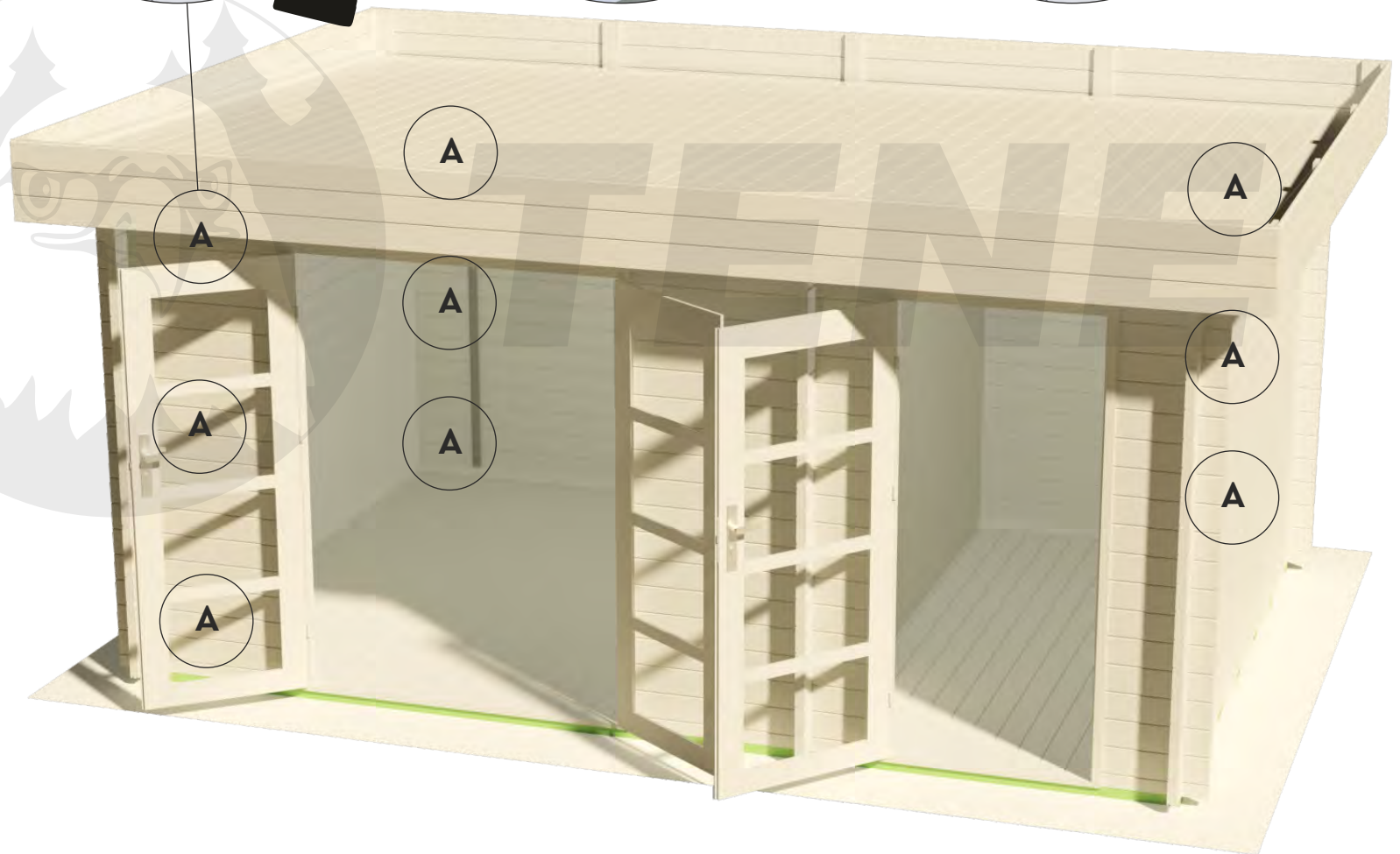
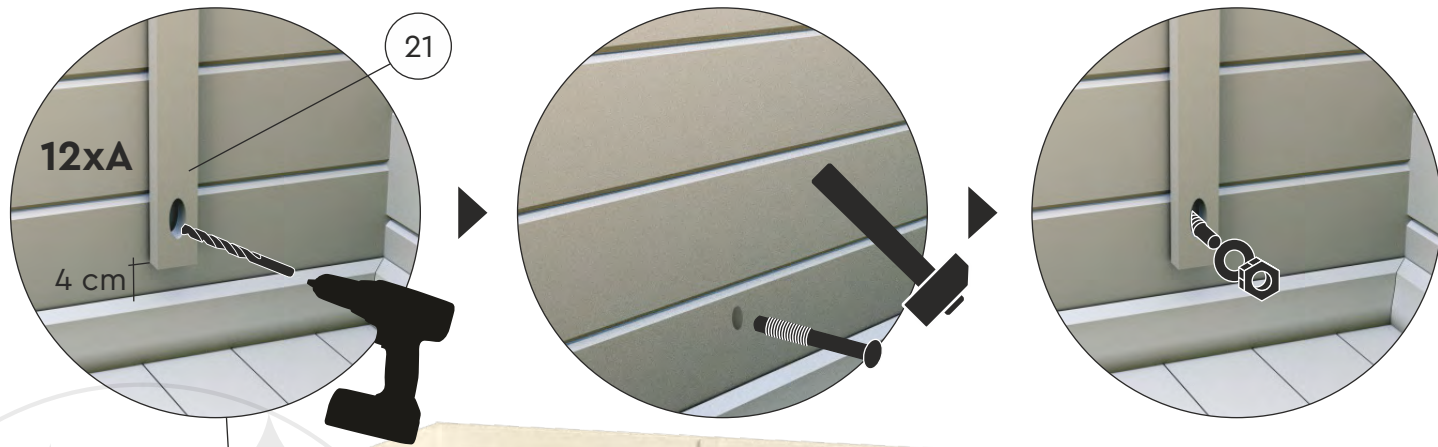

ORIENTAL 4 40

